

LINHY®

zhongshan Linyi technology co., Ltd

www.ly-leds.com

Grille Lamp Series

*Like stars to decorate your place
in a comfortable atmosphere*

LINHY®

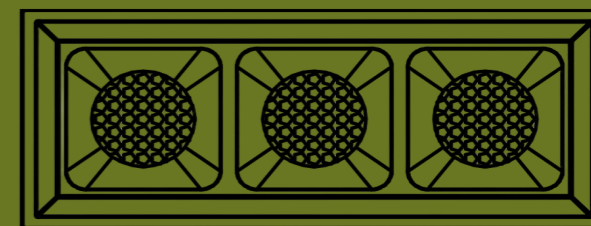

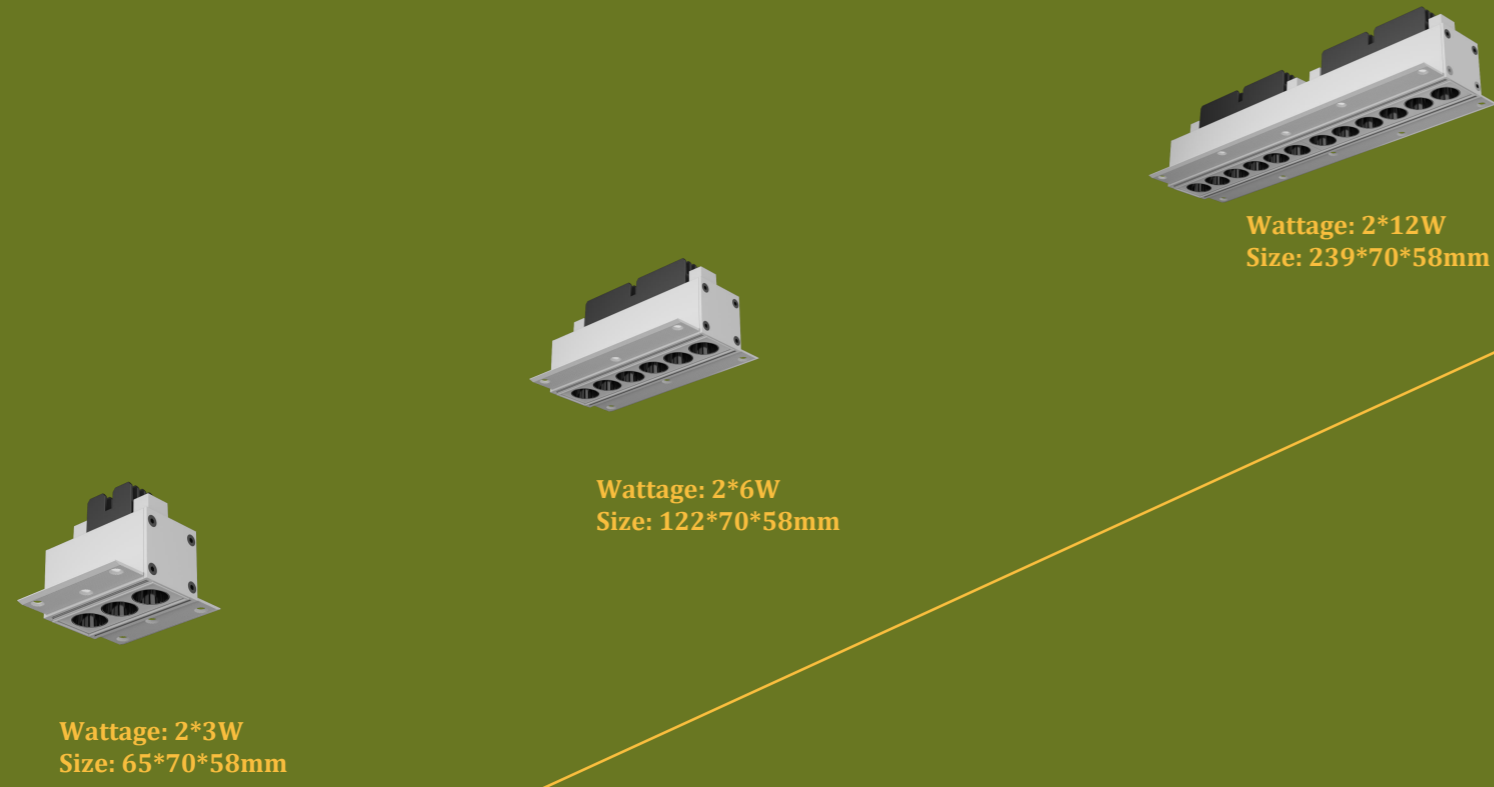

Options

Beam Angle



Non-dim 0-10V

TRIAC DALI

Temperature



Diffuser



Basic Info.



UGR<10

CRI>93

Applications: office, retail display zones, hotel lobbies, restaurant dining areas, residential

Starion



Low maintenance cost

change module easily when fixtures not work

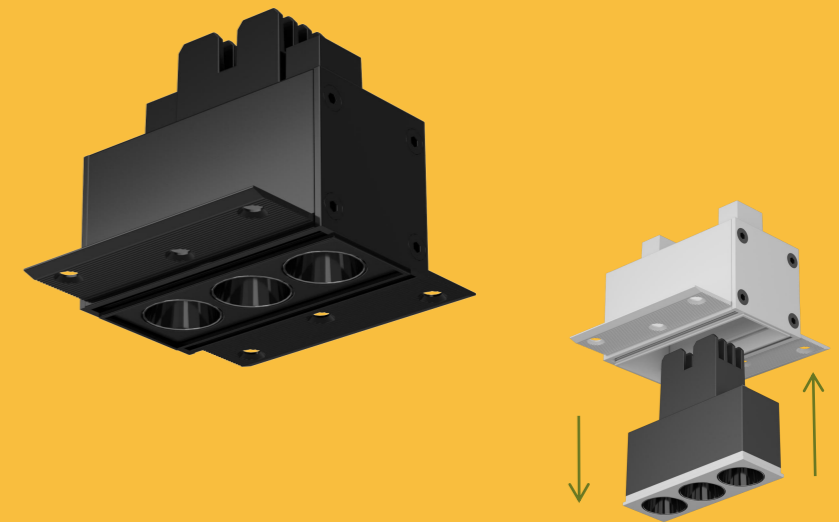

Less skus, more options



20°



40°

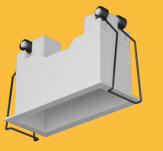
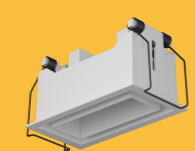
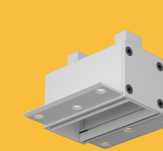

4 frames can be changed each other



7 different color reflectors

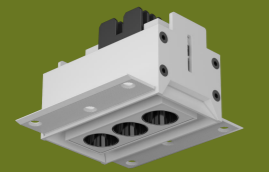

Wattage: 2*3W
Size: 76*80*59mm

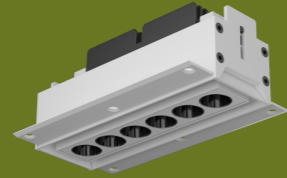

Wattage: 2*6W
Size: 133*80*59mm

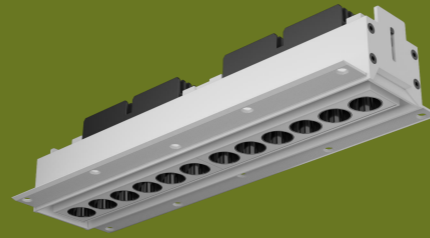

Wattage: 2*12W
Size: 251*80*59mm

Options

Beam Angle



Non-dim 0-10V

TRIAC DALI

Temperature



Diffuser



Basic Info.



UGR<10

CRI>93

Applications: office, retail display zones, hotel lobbies, restaurant dining areas, residential

Starion



Low maintenance cost

change module easily when fixtures not work



20° 20°

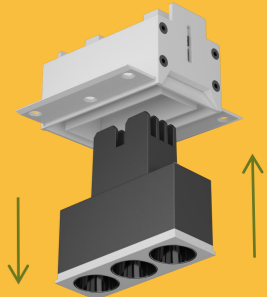

Less skus, more options



20°



40°

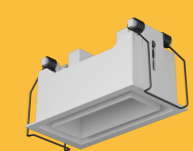
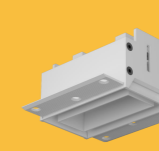
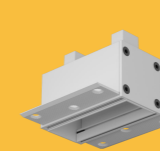

4 frames can be changed each other



7 different color reflectors

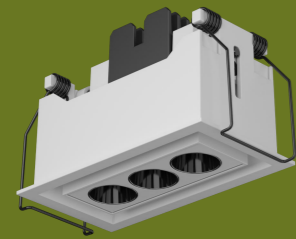

Wattage: 2*3W
Size: 85*46*58mm

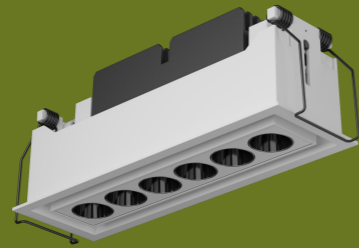

Wattage: 2*6W
Size: 142*46*58mm

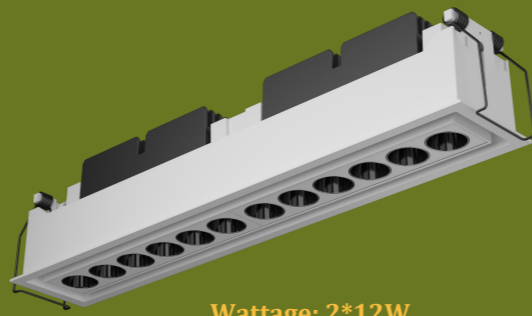

Wattage: 2*12W
Size: 259*46*58mm

Options

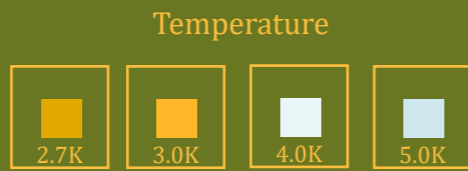

Basic Info.



UGR<10

CRI>93

Applications: office, retail display zones, hotel lobbies, restaurant dining areas, residential

Starion



Low maintenance cost

change module easily when fixtures not work

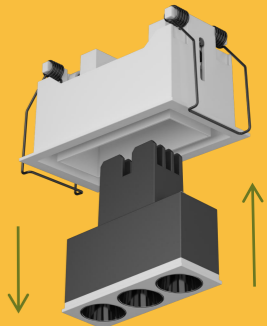

Less skus, more options



20°



40°

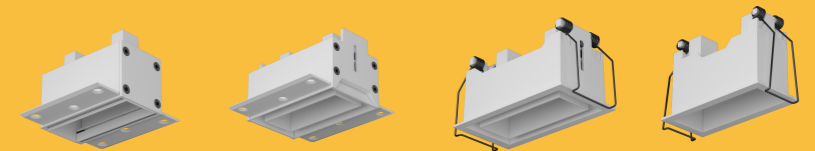

4 frames can be changed each other



7 different color reflectors

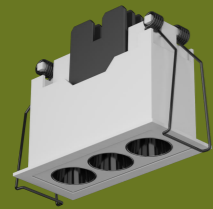

Wattage: 2*3W
Size: 70*32*58mm

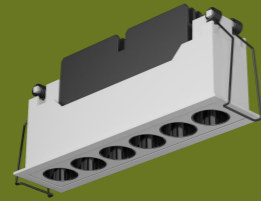

Wattage: 2*6W
Size: 127*32*58mm



Wattage: 2*12W
Size: 245*32*58mm

Options

Beam Angle



Non-dim 0-10V

TRIAC DALI

Temperature



Diffuser



Basic Info.



UGR<10

CRI>93

Applications: office, retail display zones, hotel lobbies, restaurant dining areas, residential

Starion



Low maintenance cost

change module easily when fixtures not work

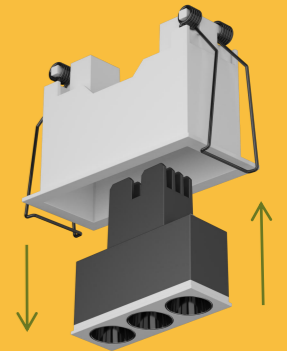

Less skus, more options



20°



40°

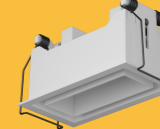
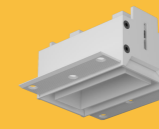

4 frames can be changed each other



7 different color reflectors

GuardianGrid

Enhanced Protection for Versatile Scenarios

With IP54 rating, it effectively resists dust and splashes. Whether in humid kitchens, dusty workshops, or semi-open outdoor areas, it can emit light stably and extend its service life.

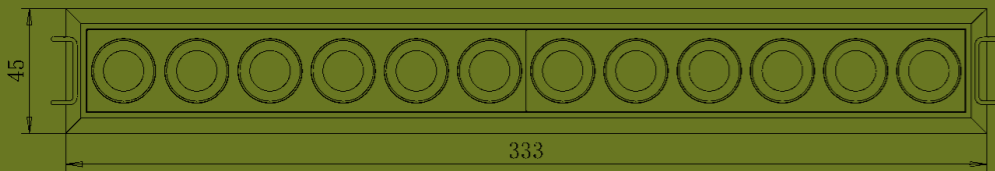

Wattage: 2*3W
Size: 85*46*58mm

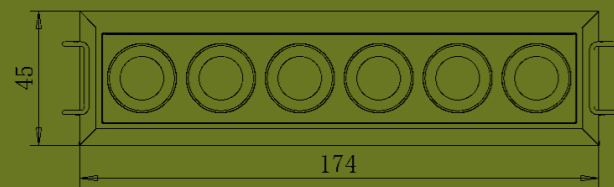

Wattage: 2*3W
Size: 85*46*58mm

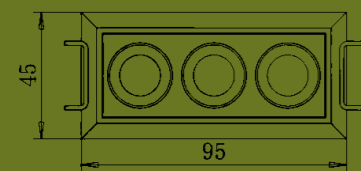

Wattage: 2*3W
Size: 85*46*58mm

Options

Beam Angle



Non-dim 0-10V

TRIAC DALI

Temperature



Diffuser



Basic Info.



UGR<10

CRI>93

Powerstars

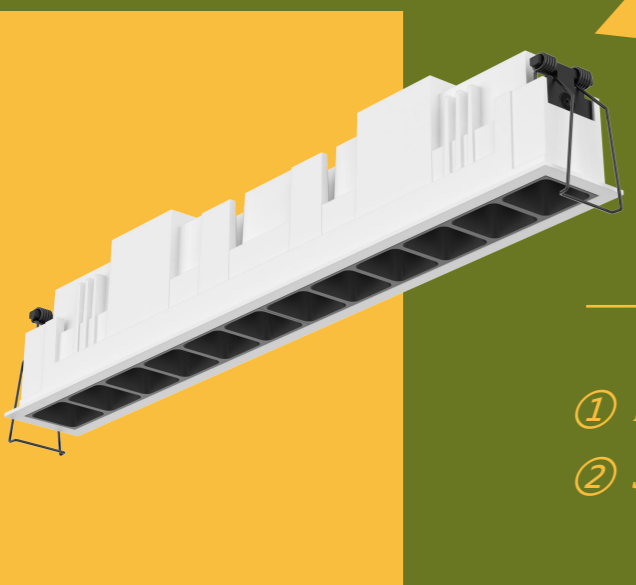

Small-Sized, High-Power Lighting:

- ① Integrated die-casting aluminum mold
- ② Special shape of heatsink, high heat-dissipation efficacy

Different options of reflectors

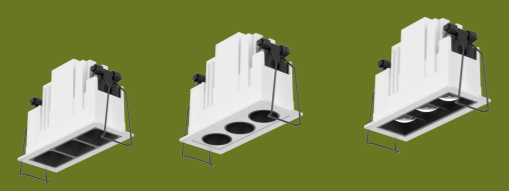

Options

Beam Angle

20°
 40°

Non-dim 0-10V
 dimming

TRIAC
 DALI

Temperature

2.7K
 3.0K
 4.0K
 5.0K

Diffuser

(with lines)
 (with dots)

Basic Info.

RoHS
 CE
 UGR<10
 CRI>93

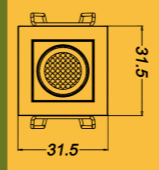

Wattage: 1*2.5W
Size: 31.5*31.5*55mm

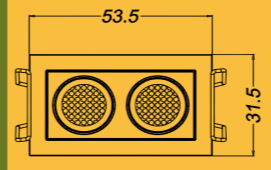

Wattage: 2*2.5W
Size: 53.5*31.5*55mm

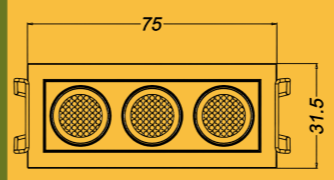

Wattage: 3*2.5W
Size: 75*31.5*55mm

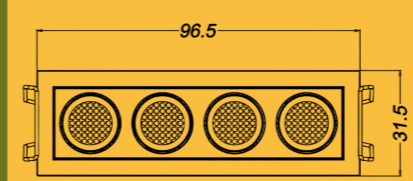

Wattage: 4*2.5W
Size: 96.5*31.5*55mm

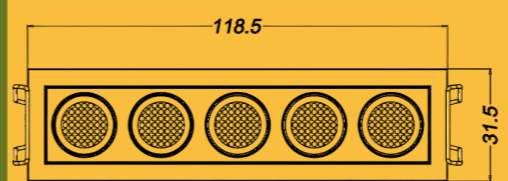

Wattage: 5*2.5W
Size: 118.5*31.5*55mm

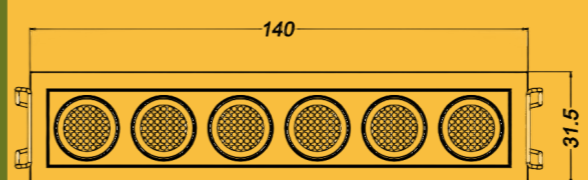

Wattage: 6*2.5W
Size: 140*31.5*55mm

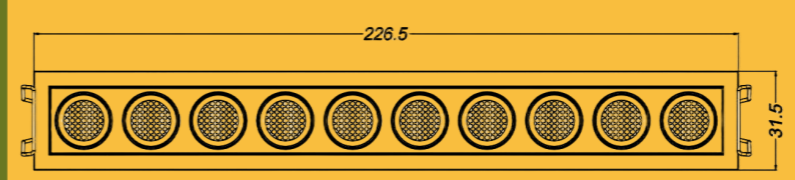

Wattage: 10*2.5W
Size: 226.5*31.5*55mm

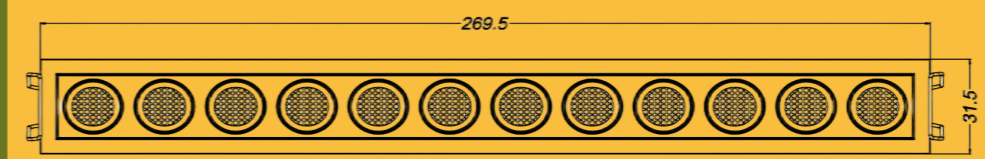

Wattage: 12*2.5W
Size: 269.5*31.5*55mm



Wattage: 10*2W
Size: 268*35*70mm

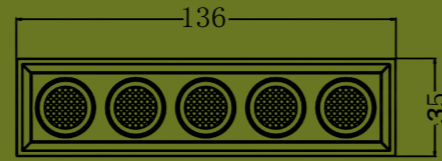

Wattage: 5*2W
Size: 136*35*70mm

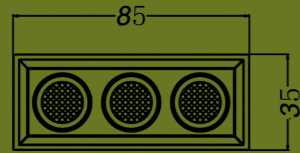

Wattage: 3*2W
Size: 85*35*70mm

Eclat Cube



Options

Beam Angle



Non-dim 0-10V

TRIAC DALI

Temperature



Diffuser



Basic Info.



UGR<10

CRI>93

ShadowCaster

Multi beams, sculpting spaces.
Where sleek design meets precise illumination, redefining ambient artistry



Options

Beam Angle



20°



40°



dimming

Non-dim 0-10V

TRIAC

DALI

Temperature



2.7K



3.0K



4.0K



5.0K

Diffuser



Basic Info.



UGR<10

CRI>93

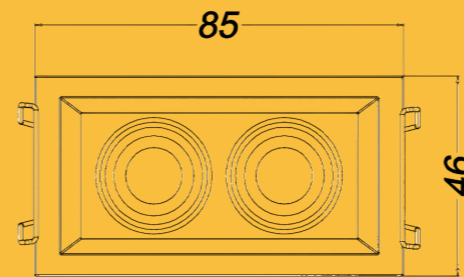

Wattage: 2*3W
Size: 85*46*72.5mm

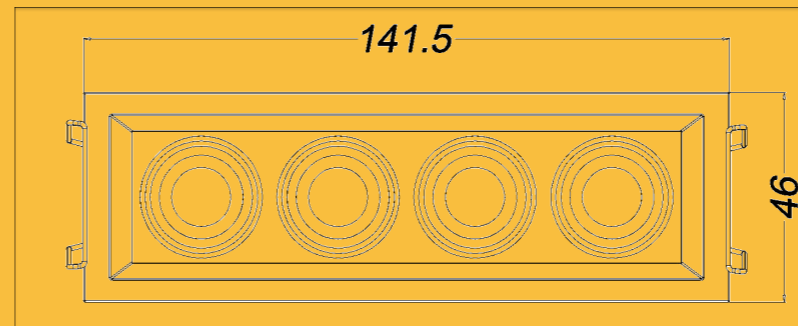

Wattage: 4*3W
Size: 141.5*46*72.5mm

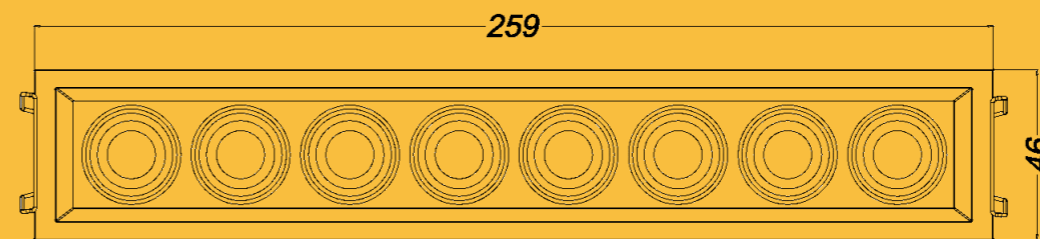

Wattage: 8*3W
Size: 259*46*72.5mm